

PAPER CRAFT

<http://www.canon.com/c-park/en/>



| | |
|--------------------------------|----------------------------------|
| Completed Model (Total length) | About 520mm (Scale - About 1:72) |
| (Total width) | About 468mm |
| Pattern | 19 pages (No. of Parts: 296) |
| Assembly Instructions | 20 pages |

Vietnam Airlines AIRBUS320

This model is based on the "Vietnam Airlines AIRBUS320," a passenger aircraft manufactured by Airbus and operated by Vietnam Airlines.

The AIRBUS320's flight path links 16 Vietnamese cities with 27 cities around the world. Passengers can enjoy everything from domestic flights within Vietnam, to sojourns to exotic Indochina locations such as the neighboring Cambodia, famous for the Angkor Wat temples, and the treasure trove of world heritage sites that is Laos, or even venture to other parts of South East Asia, Europe, Australia, etc.

The airplane's body displays Vietnam Airlines' logo, the lotus flower. Onboard, passengers are greeted by flight attendants dressed in the traditional Vietnamese "Aozai" garment.

The AIRBUS320 features an overall length of 37.57m and is 11.76m high, with a wingspan of 34.10m. With a maximum take-off weight of 77 tons and an economical cruising speed of 877 km/h (when at an altitude of 10668m), it can cover distances of up to 5,550 km.



This model was designed for Papercraft and may differ from the original in some respects.

*Build the model by carefully reading the Assembly Instructions, in the parts sheet page order.

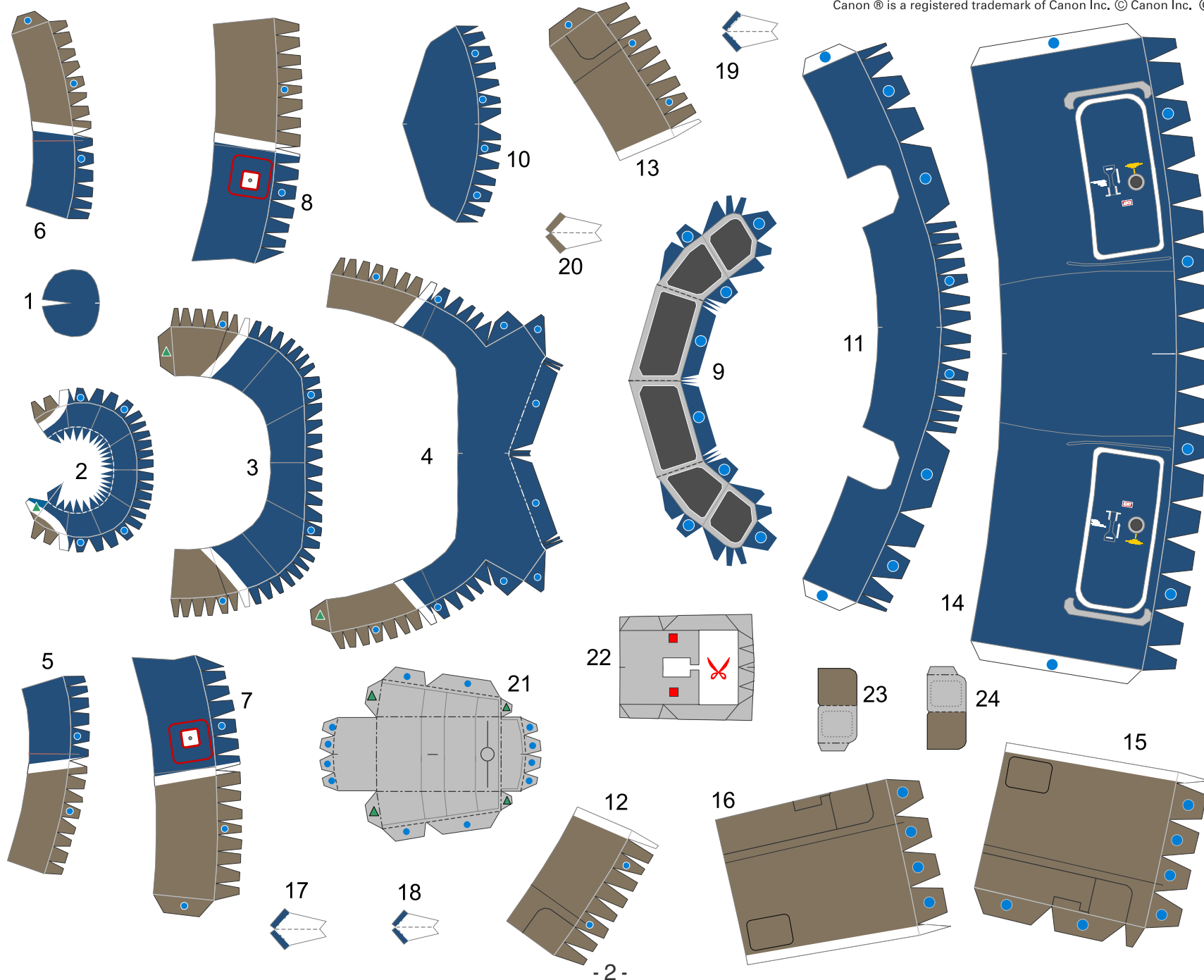

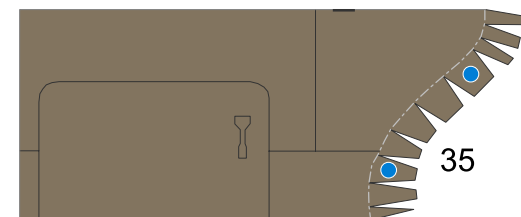
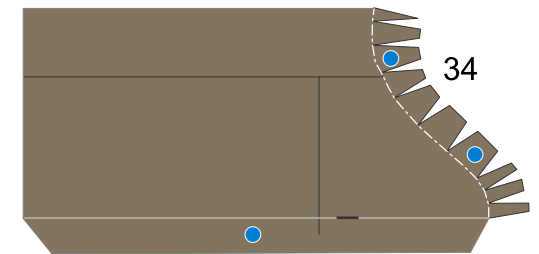
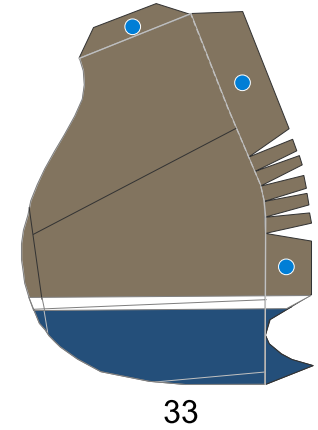
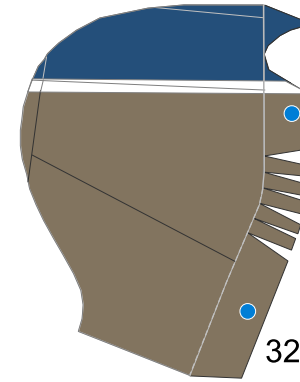
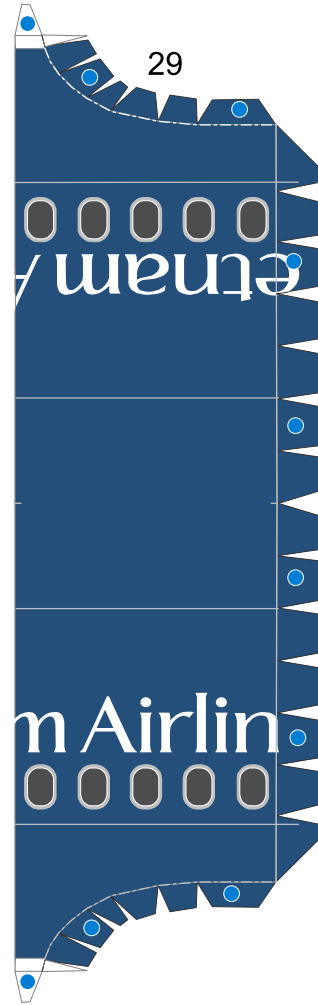
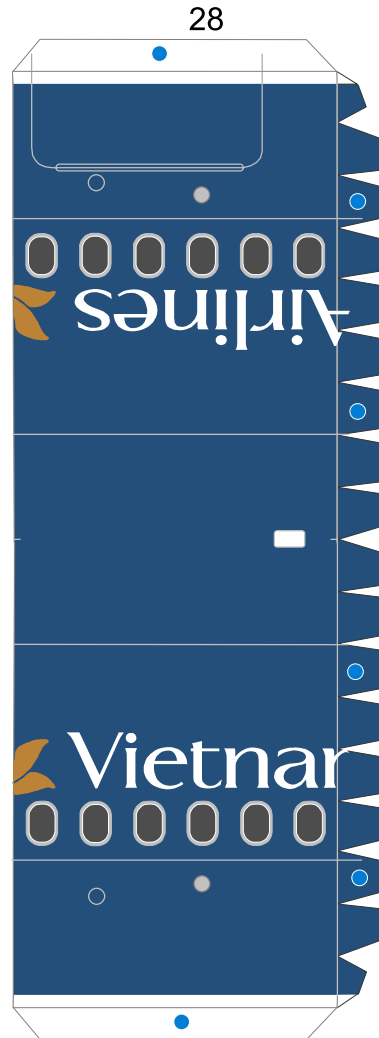
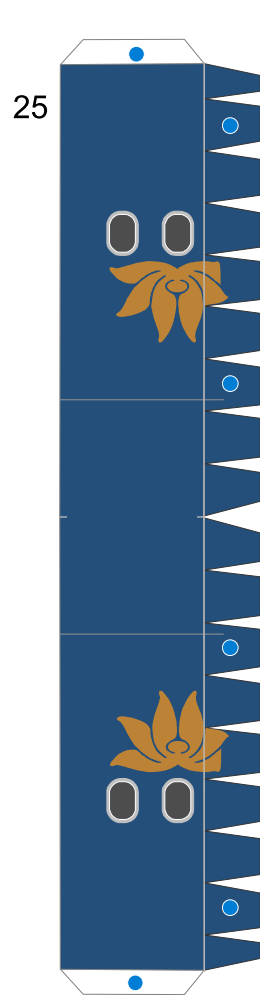
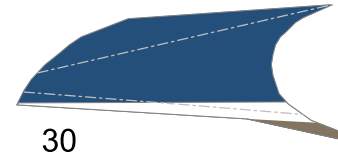
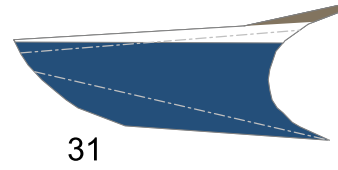
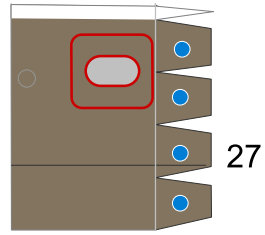
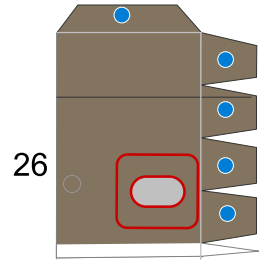

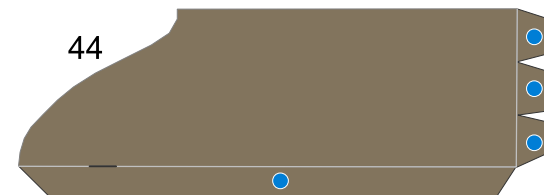
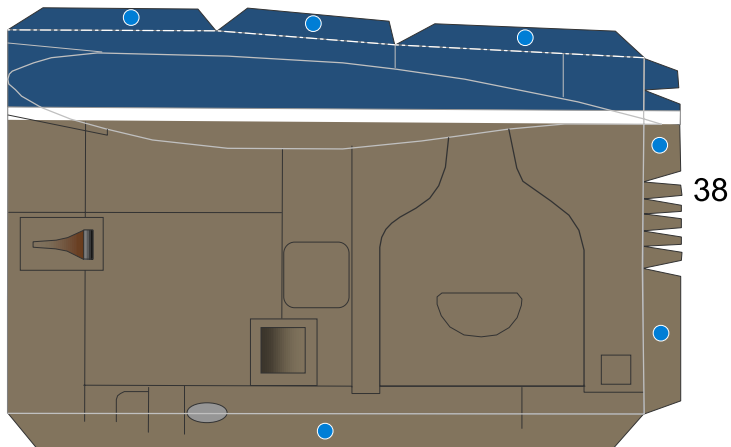
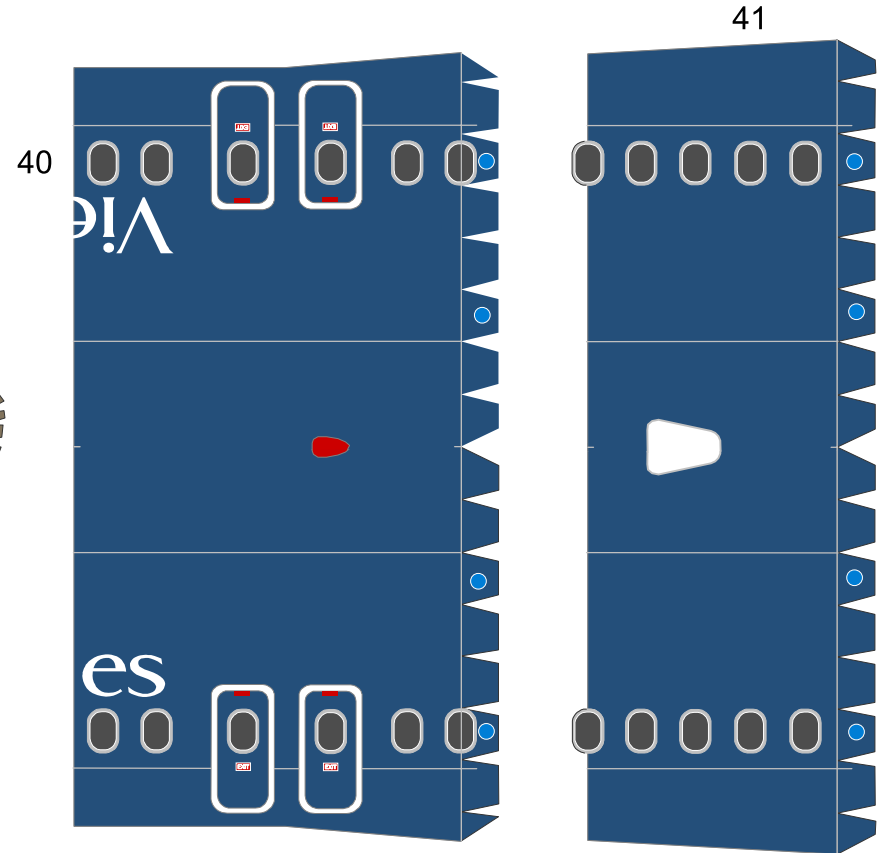
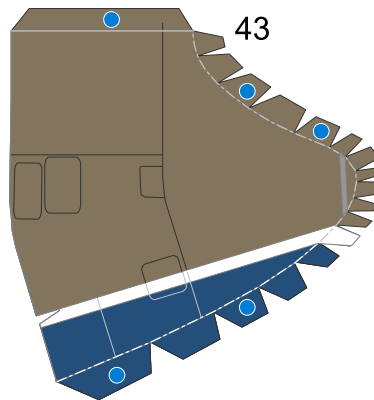
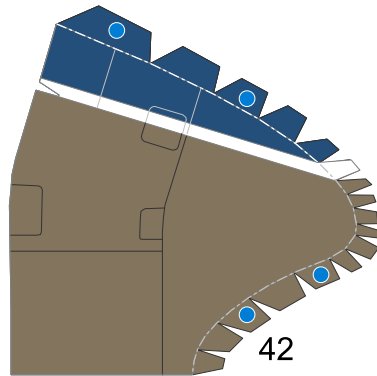
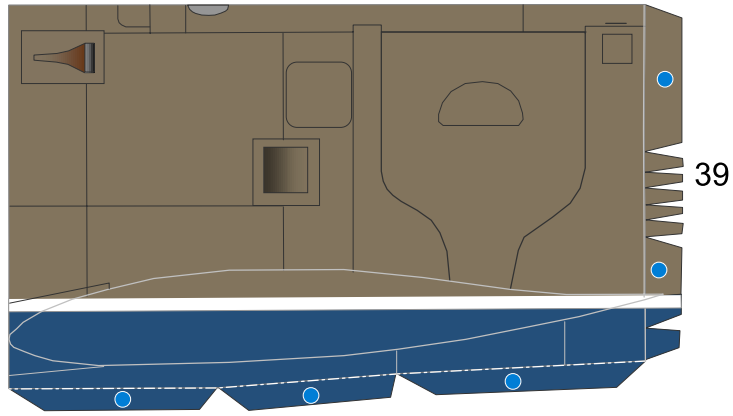

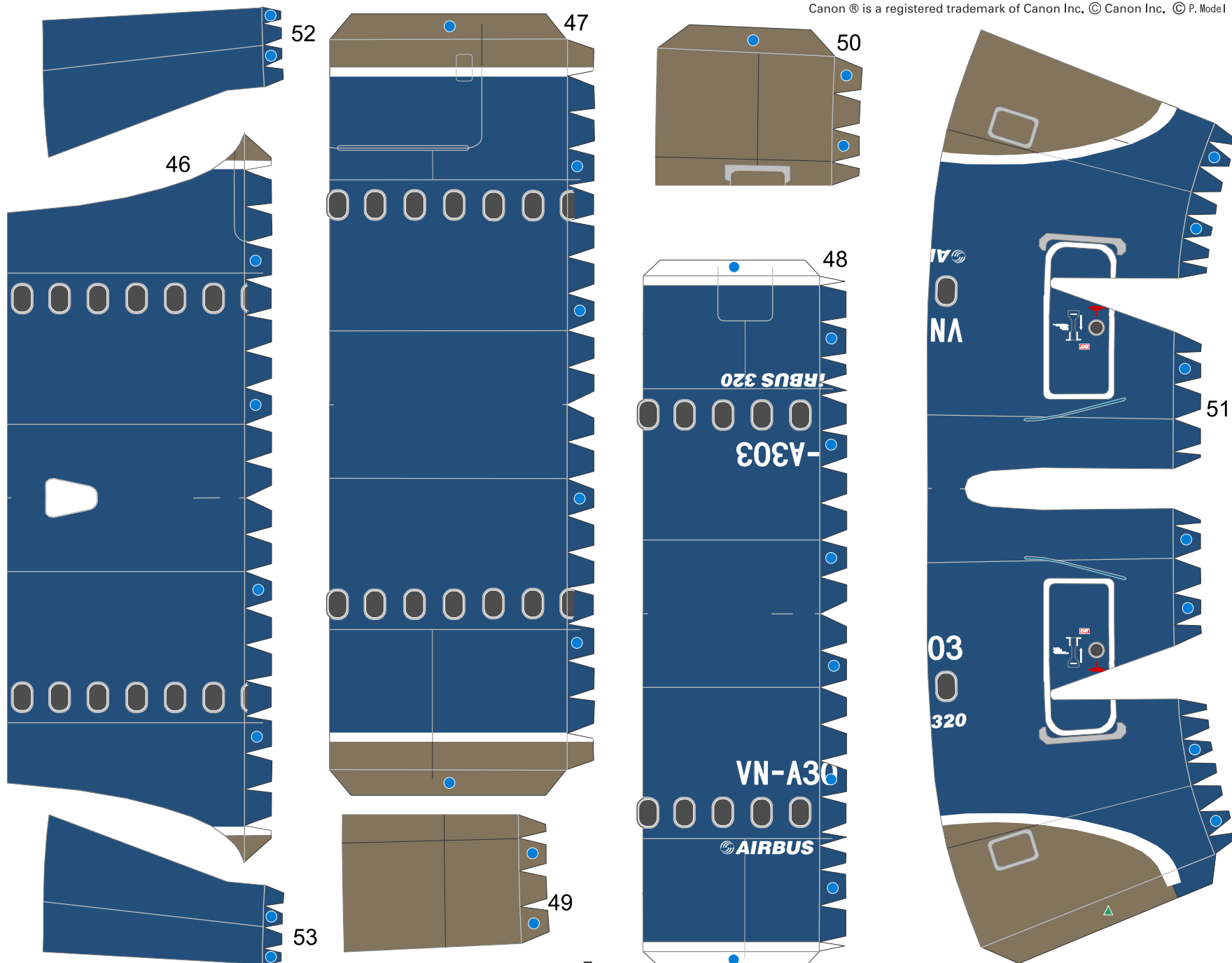

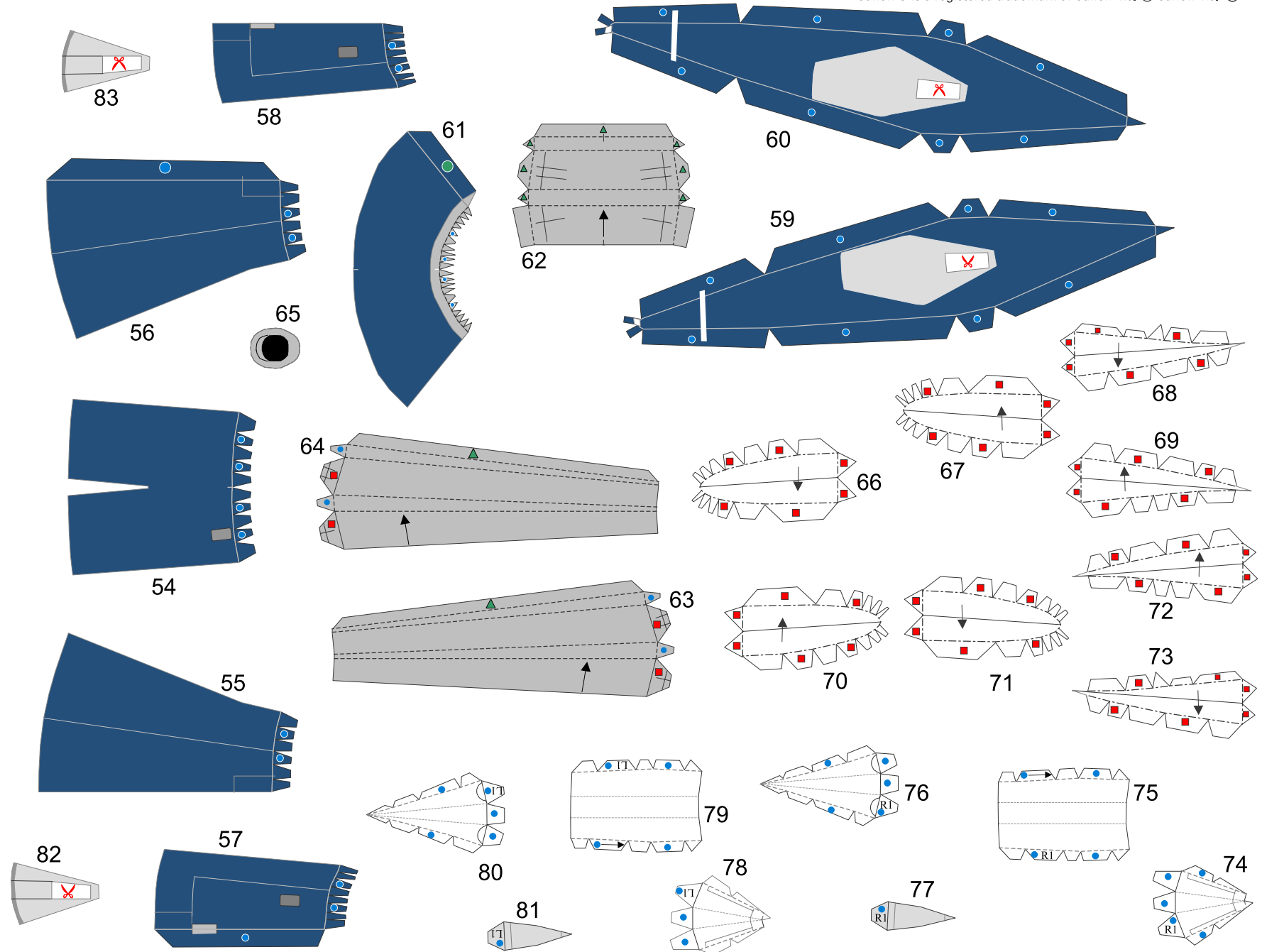

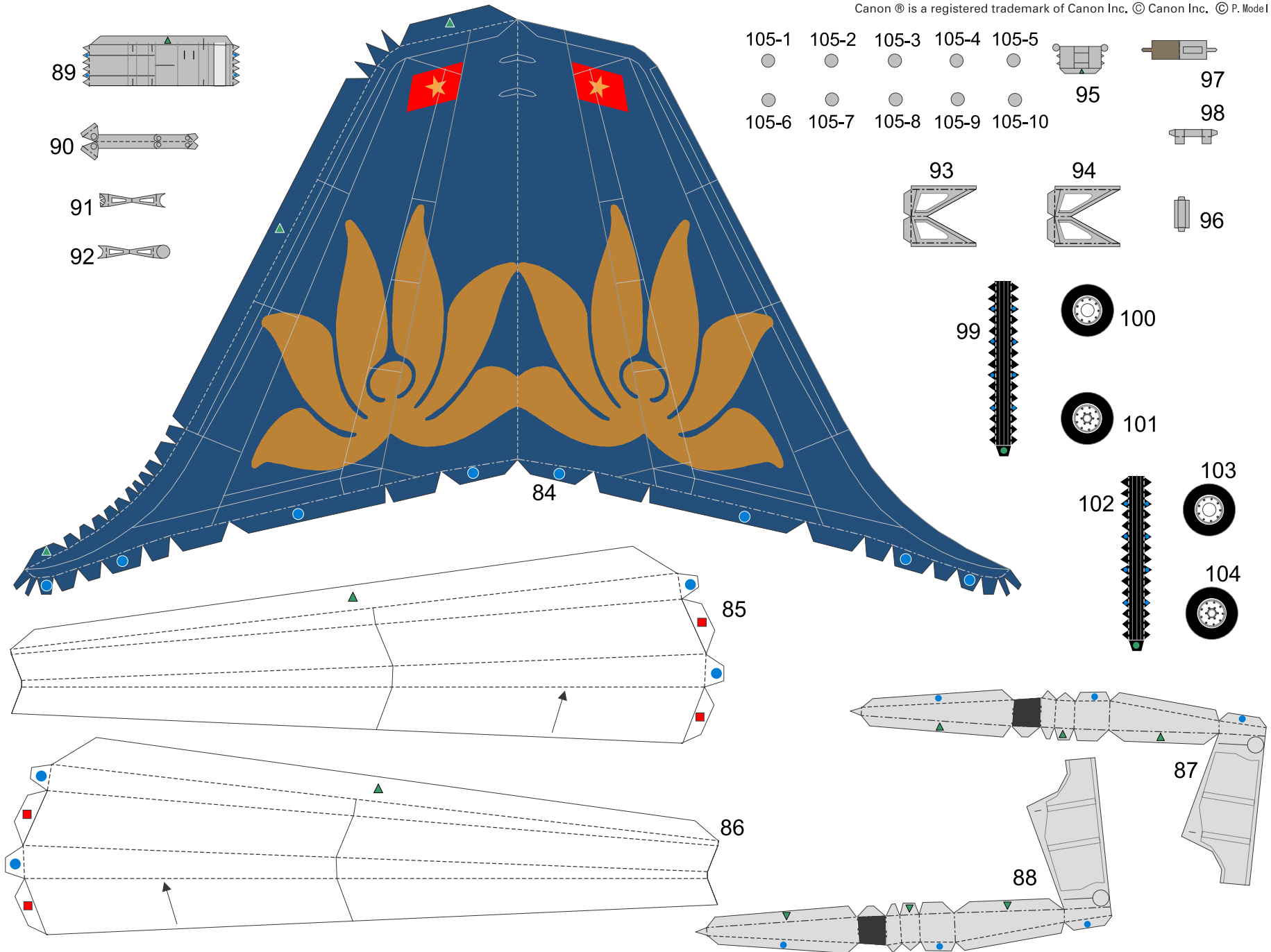

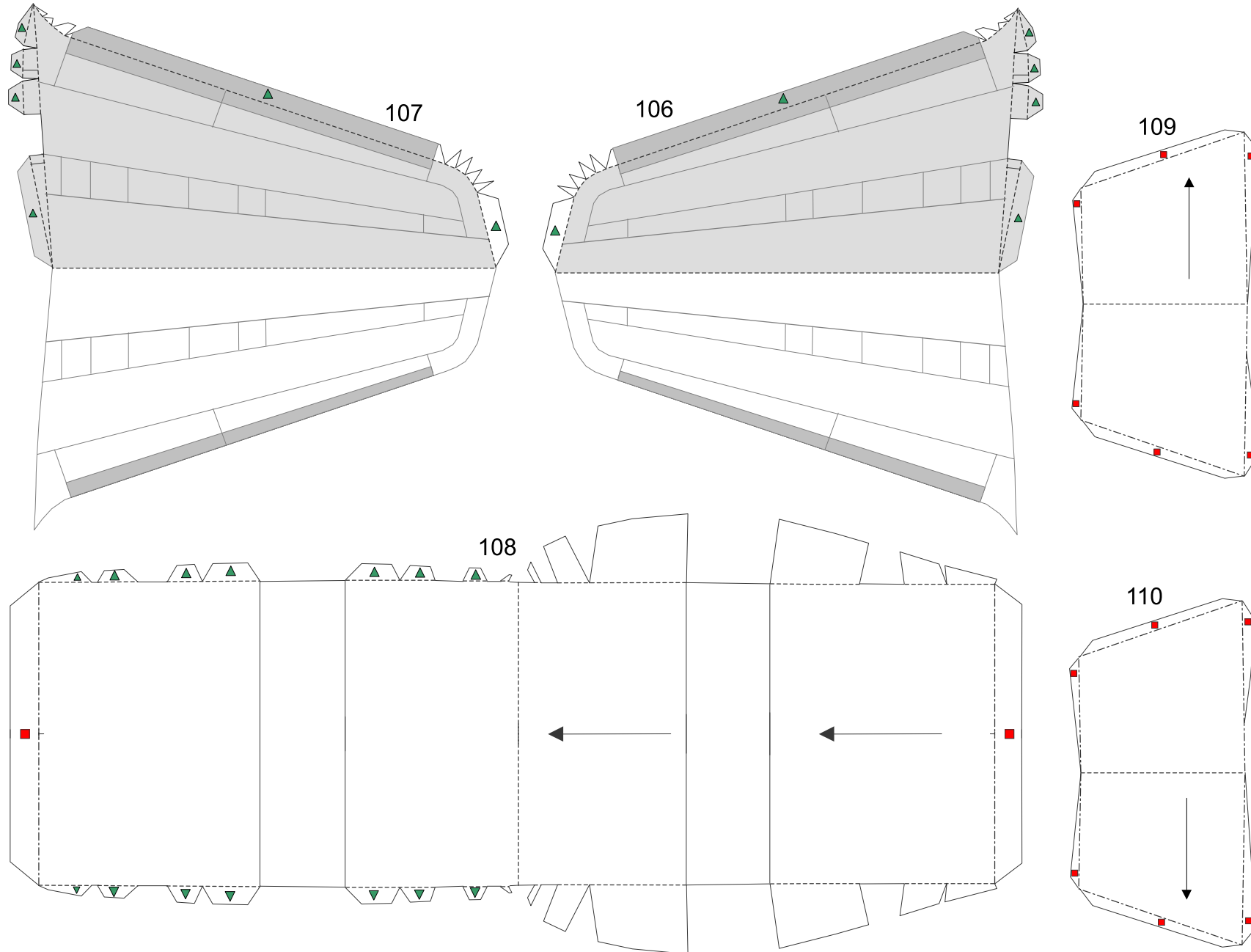

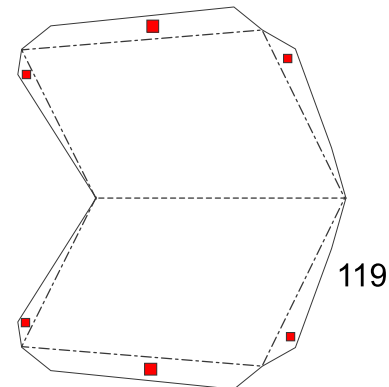
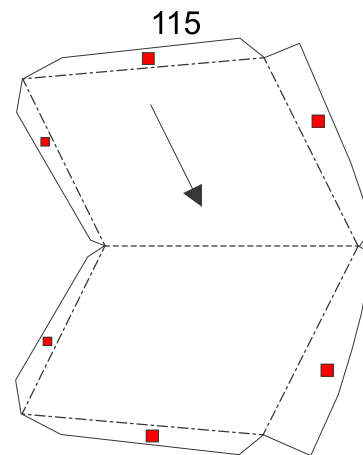
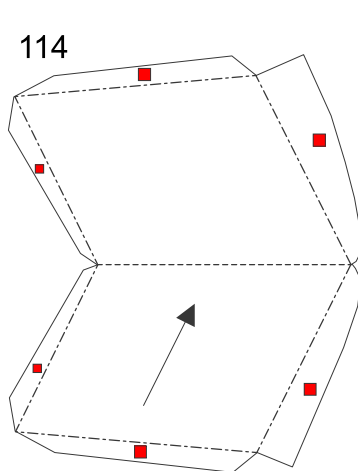
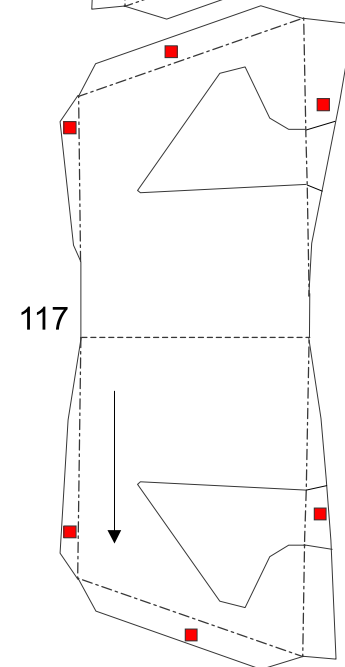
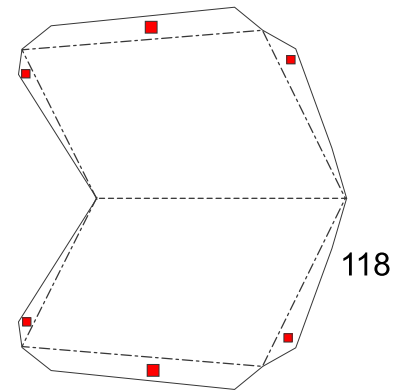
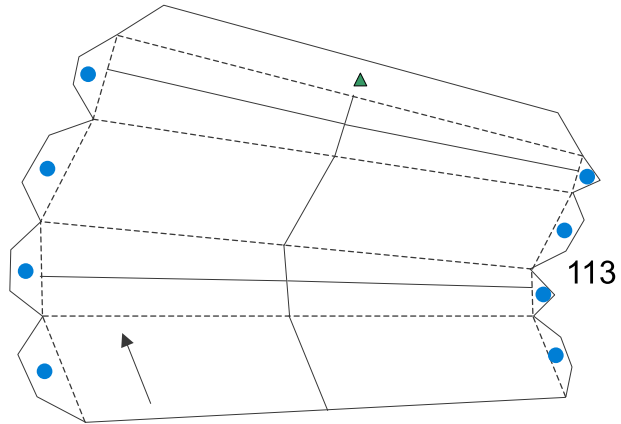
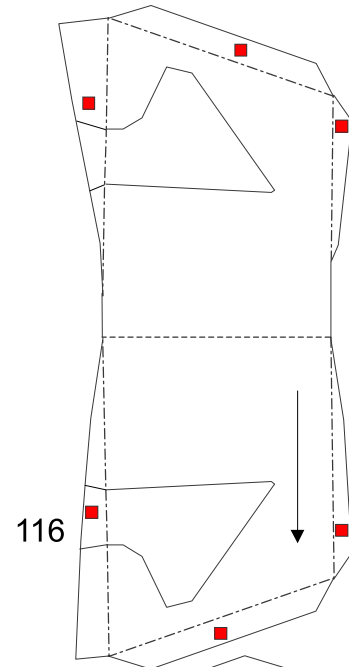
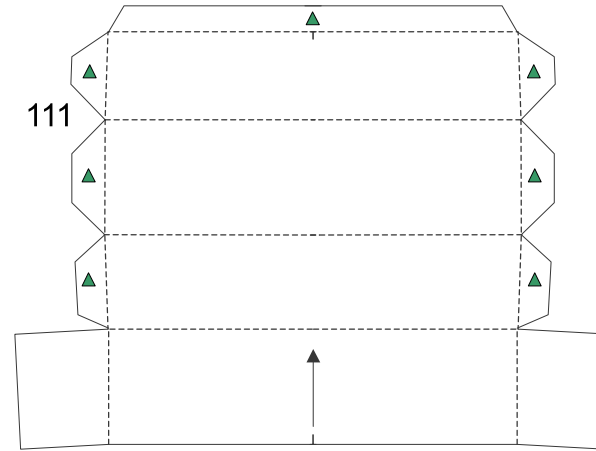
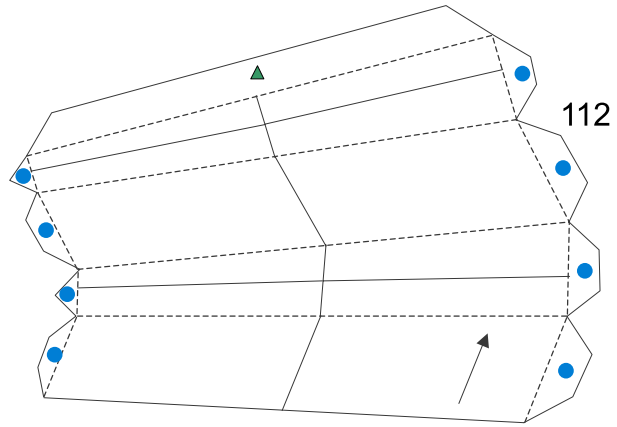

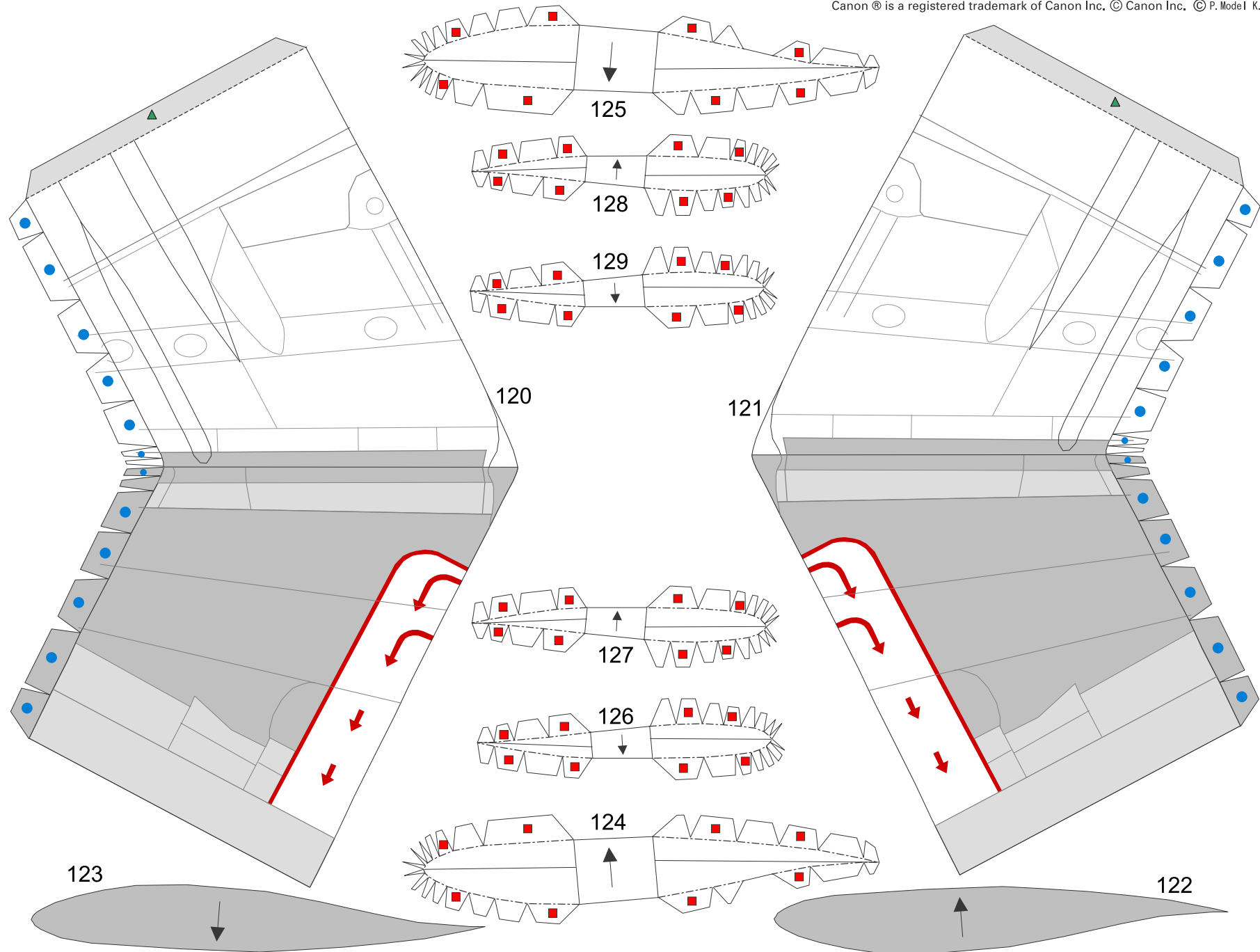

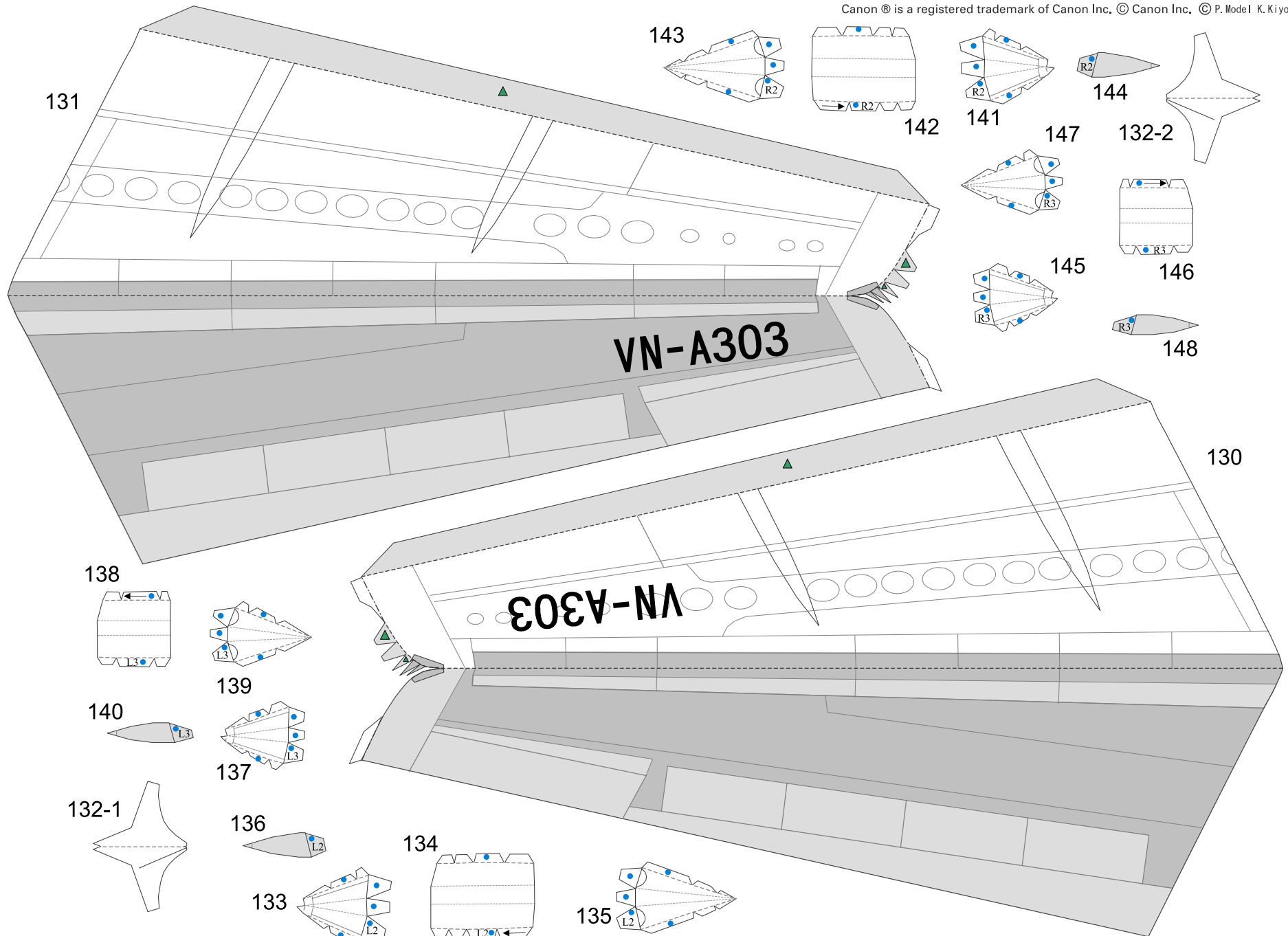

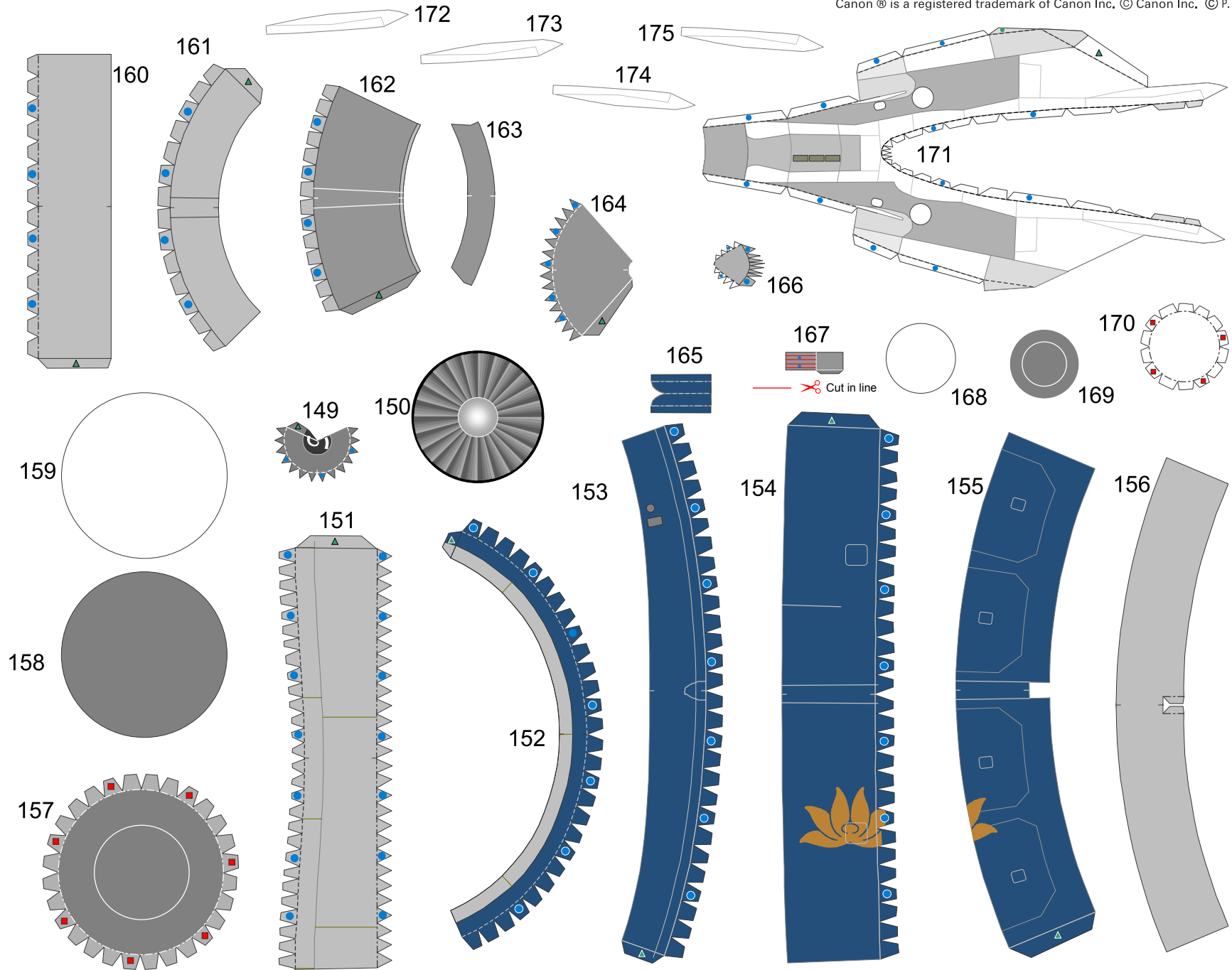

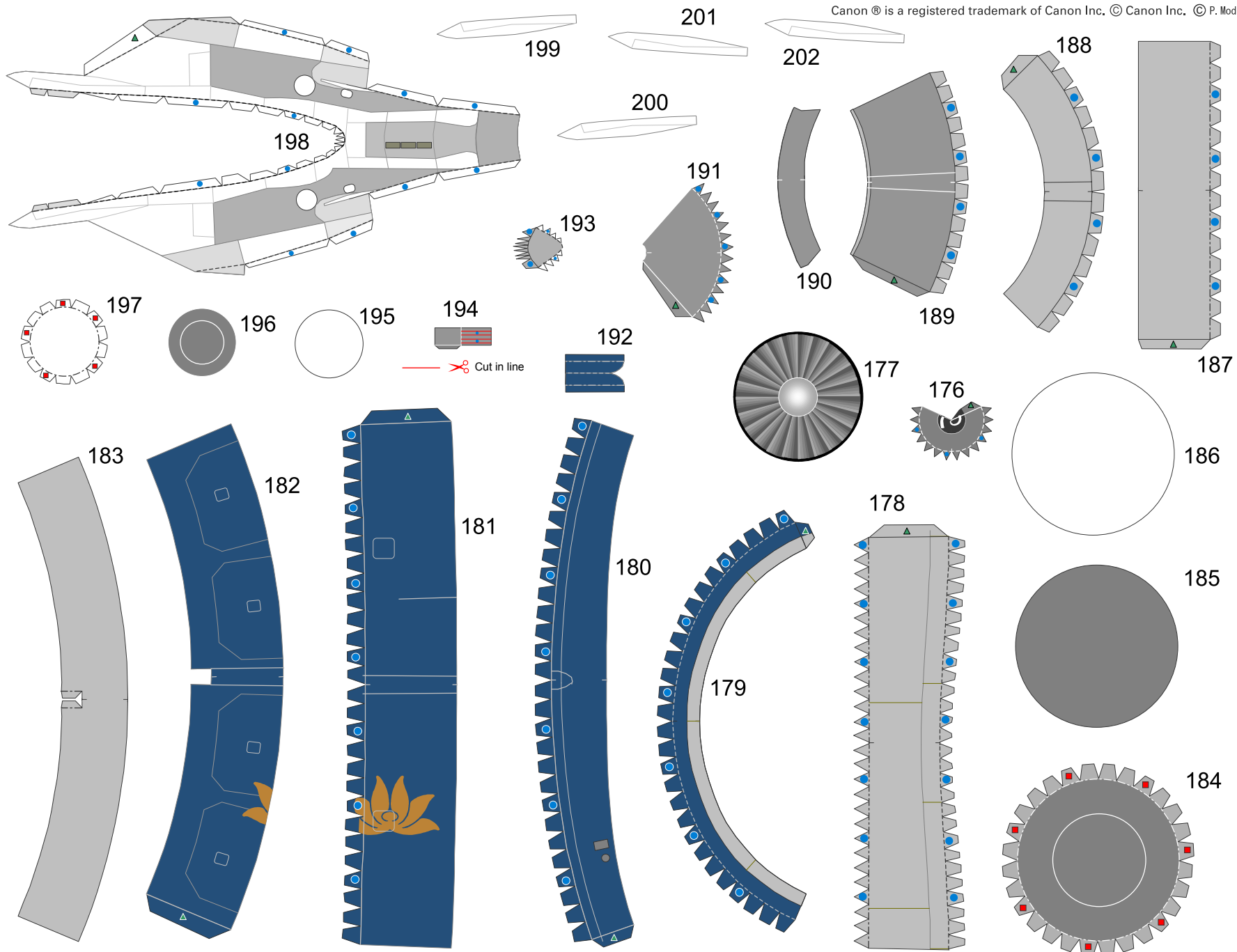

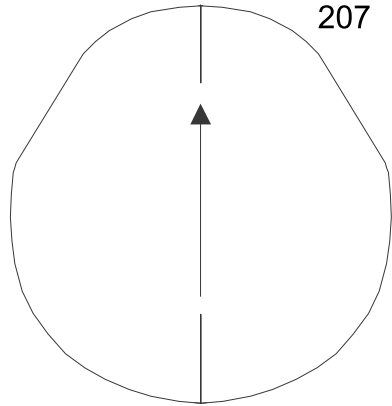

207

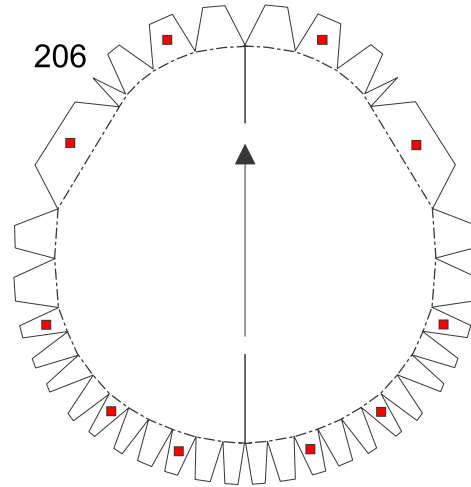

206

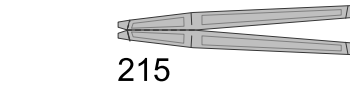

215

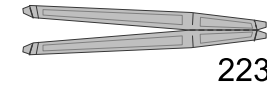

223

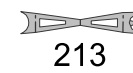

213

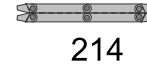

214

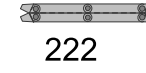

222



221



212

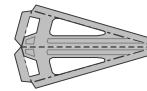

211

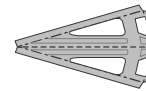

219

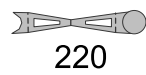

220

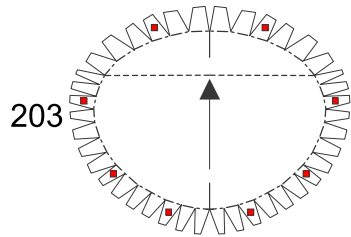

203

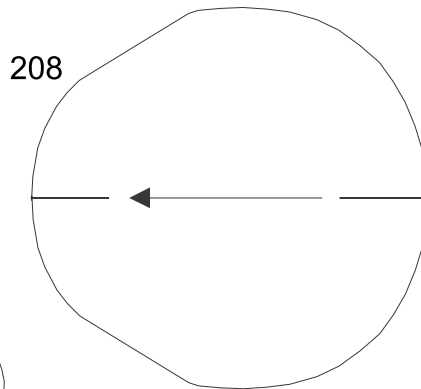

208

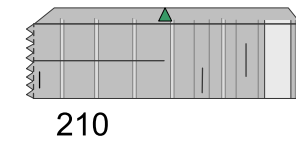

210

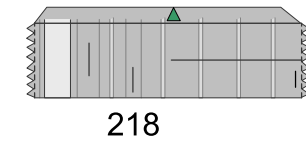

218

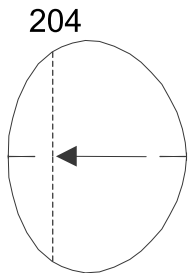

204

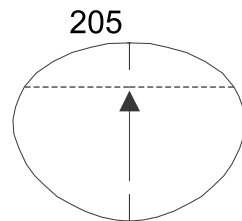

205

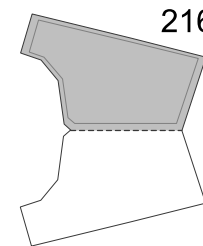

216

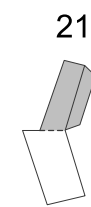

217

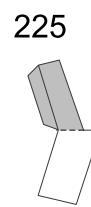

225

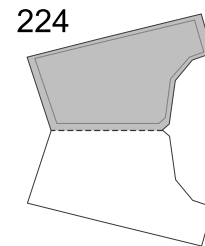

224

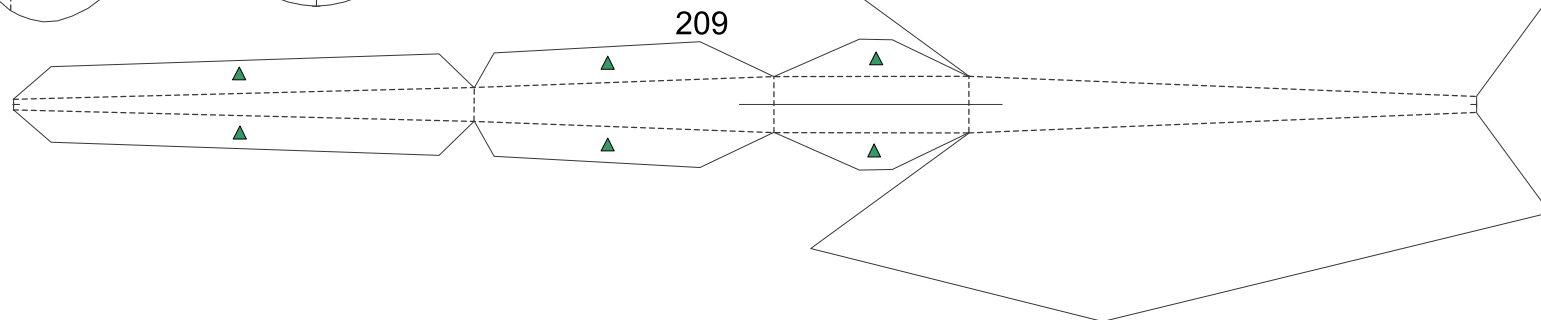

209

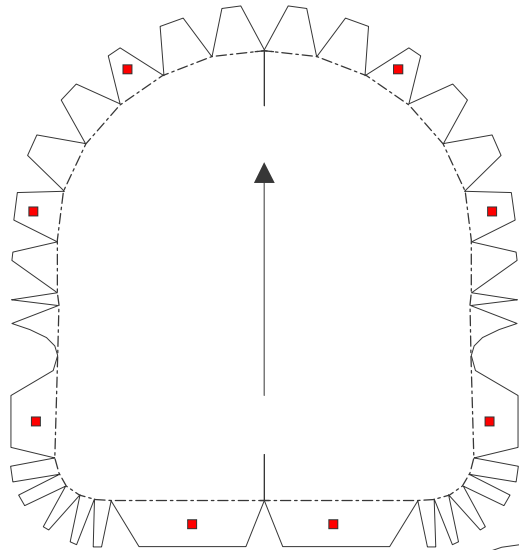

228

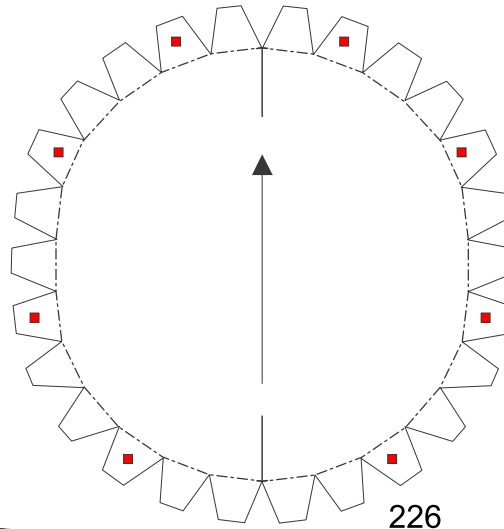

226

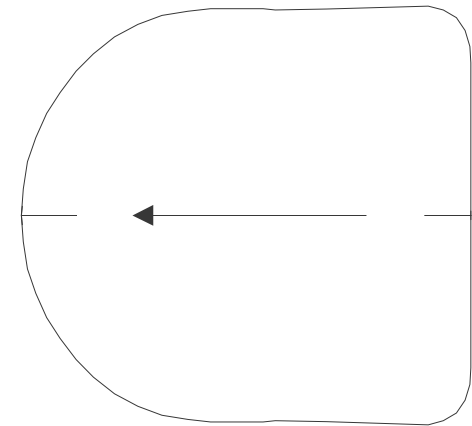

230

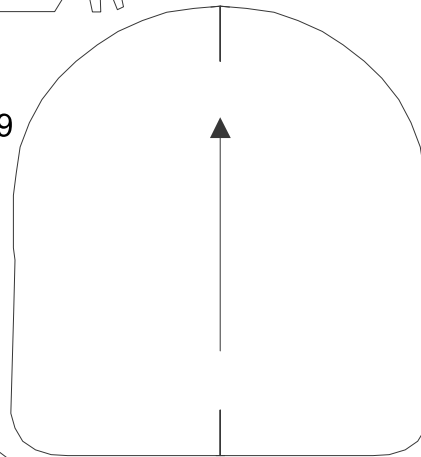

229

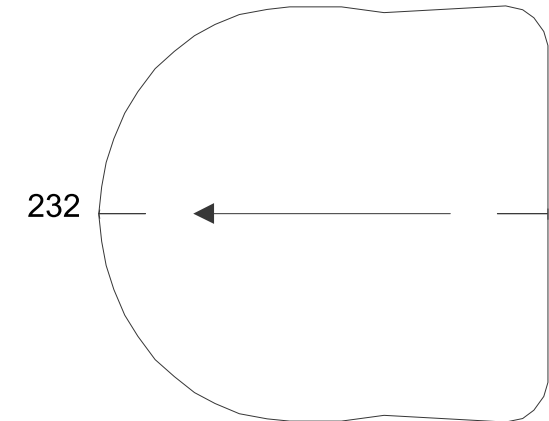

232

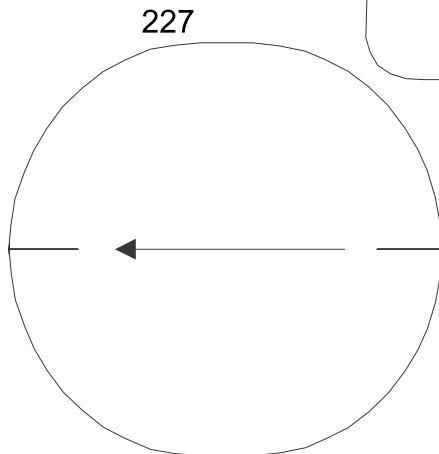

227

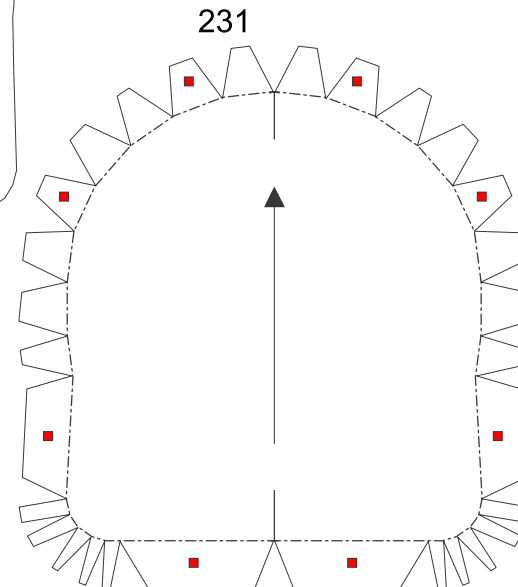

231

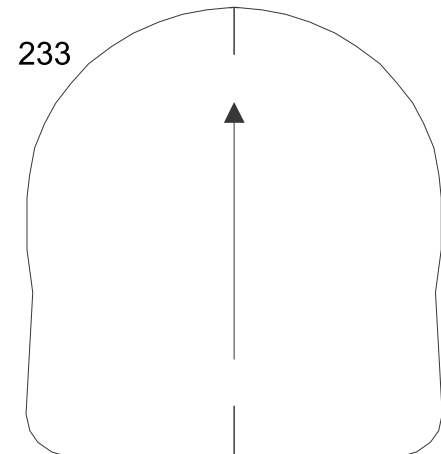

233

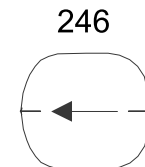
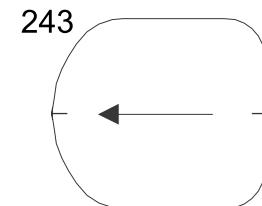
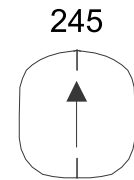
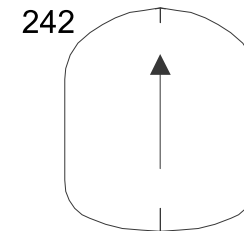
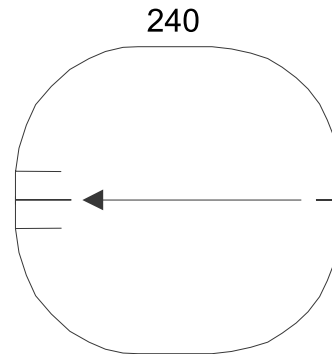
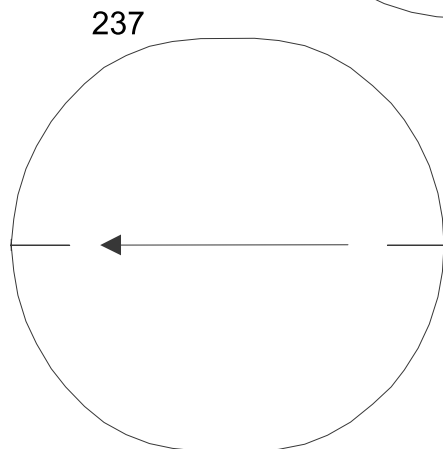
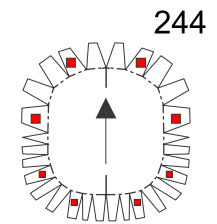
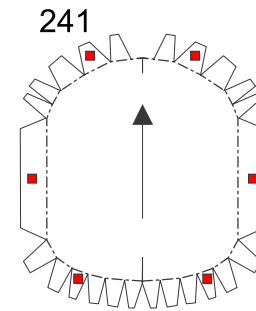
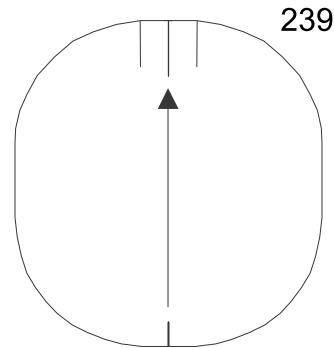
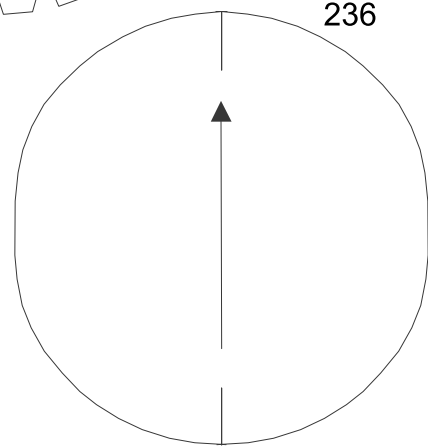
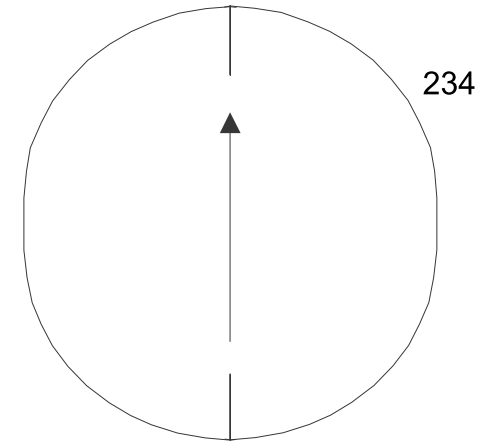
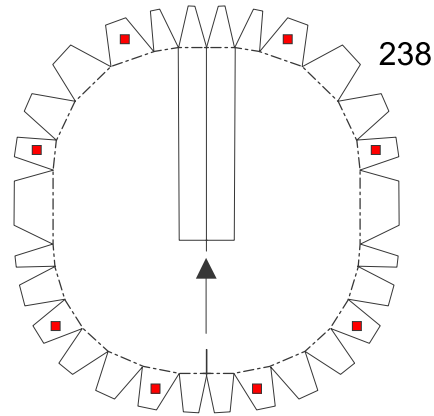
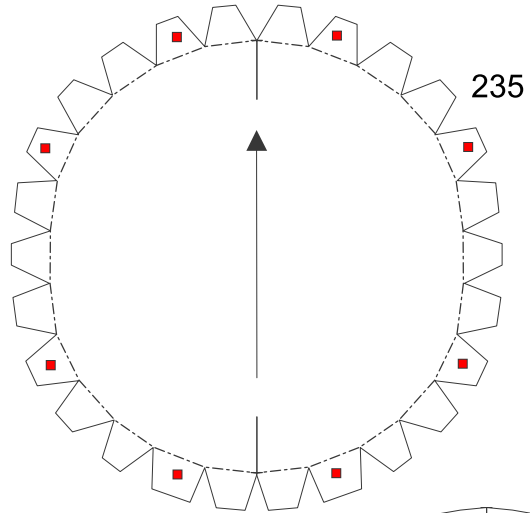

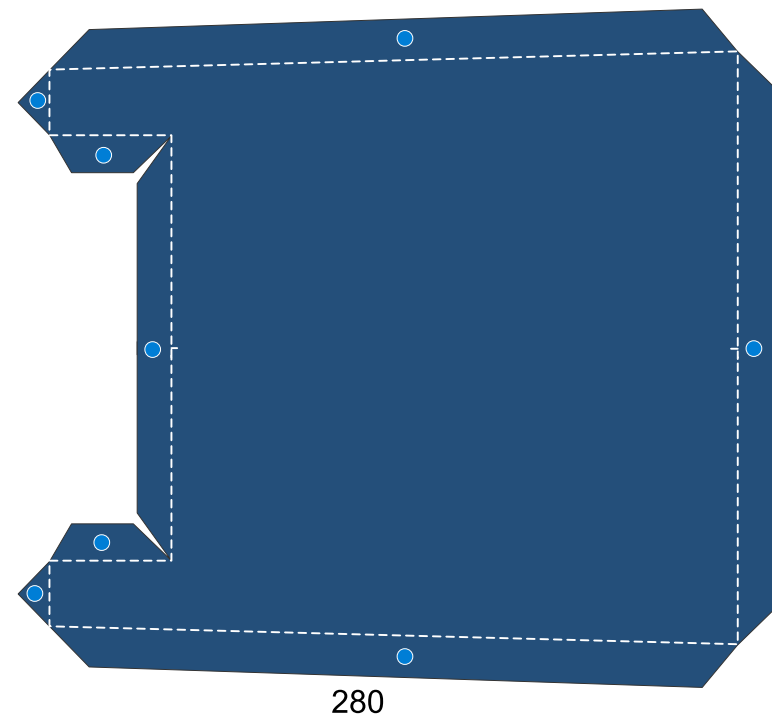
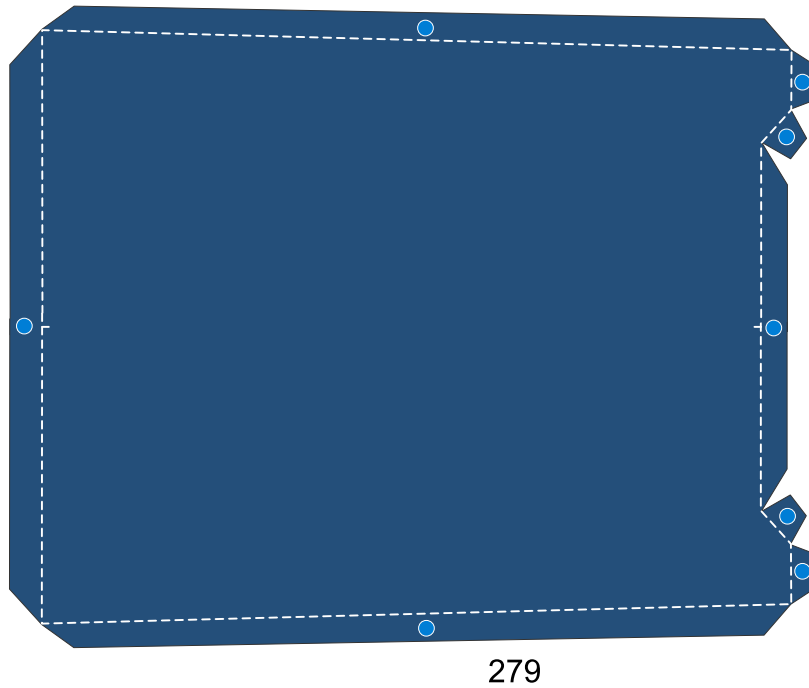
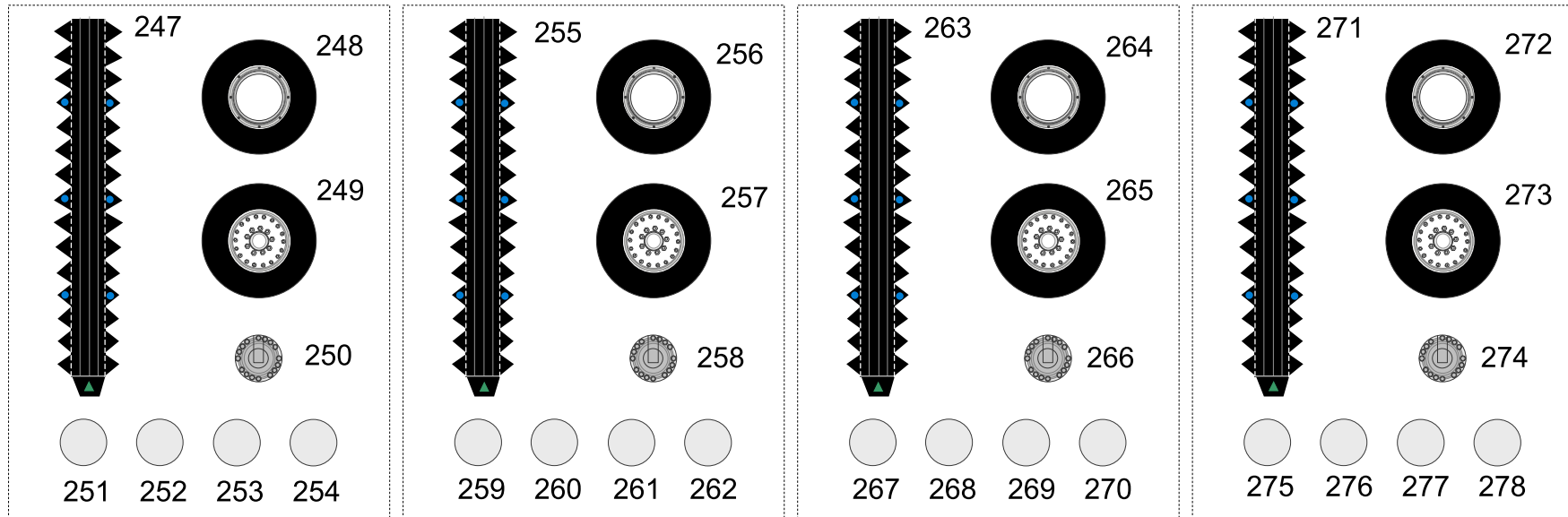

281

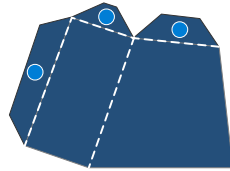

282

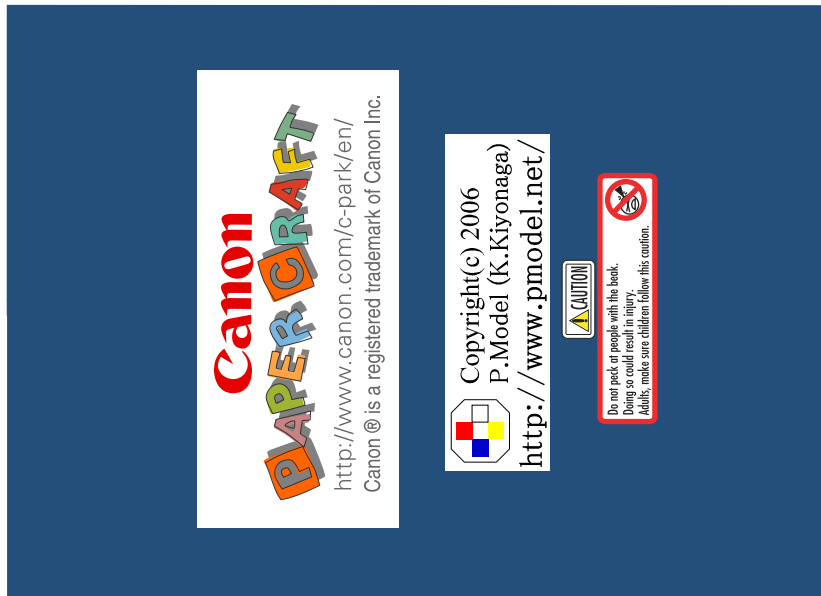
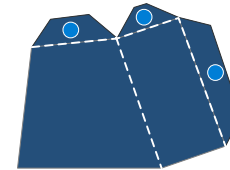

283



284

